

SECTION A-A

SECTION B-B

RANGE: Ø500 TO Ø4000

TITLE: G. A. FOR ROUND MULTIFLAP DAMPER



marsh automation pvt. ltd.

98A/25A, Hadapsar Industrial Estate,
Pune - 411 013. (INDIA)

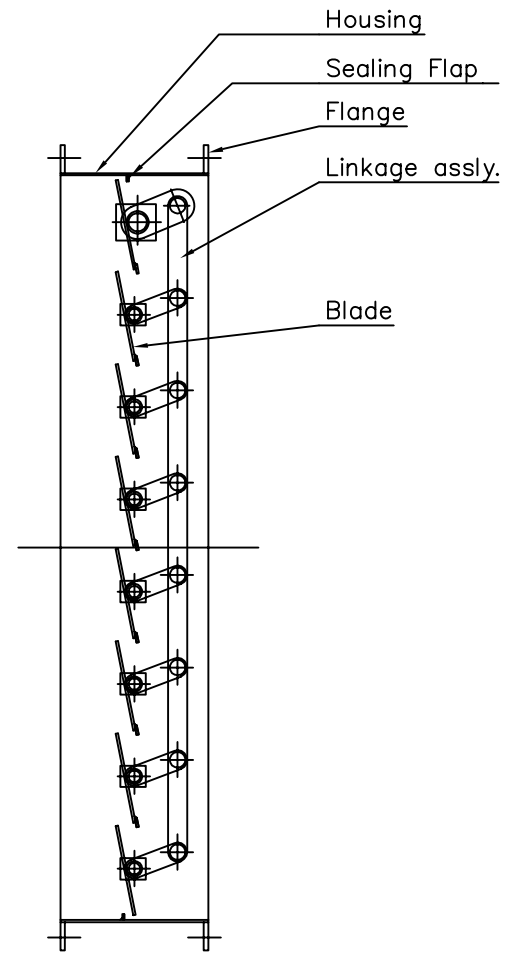
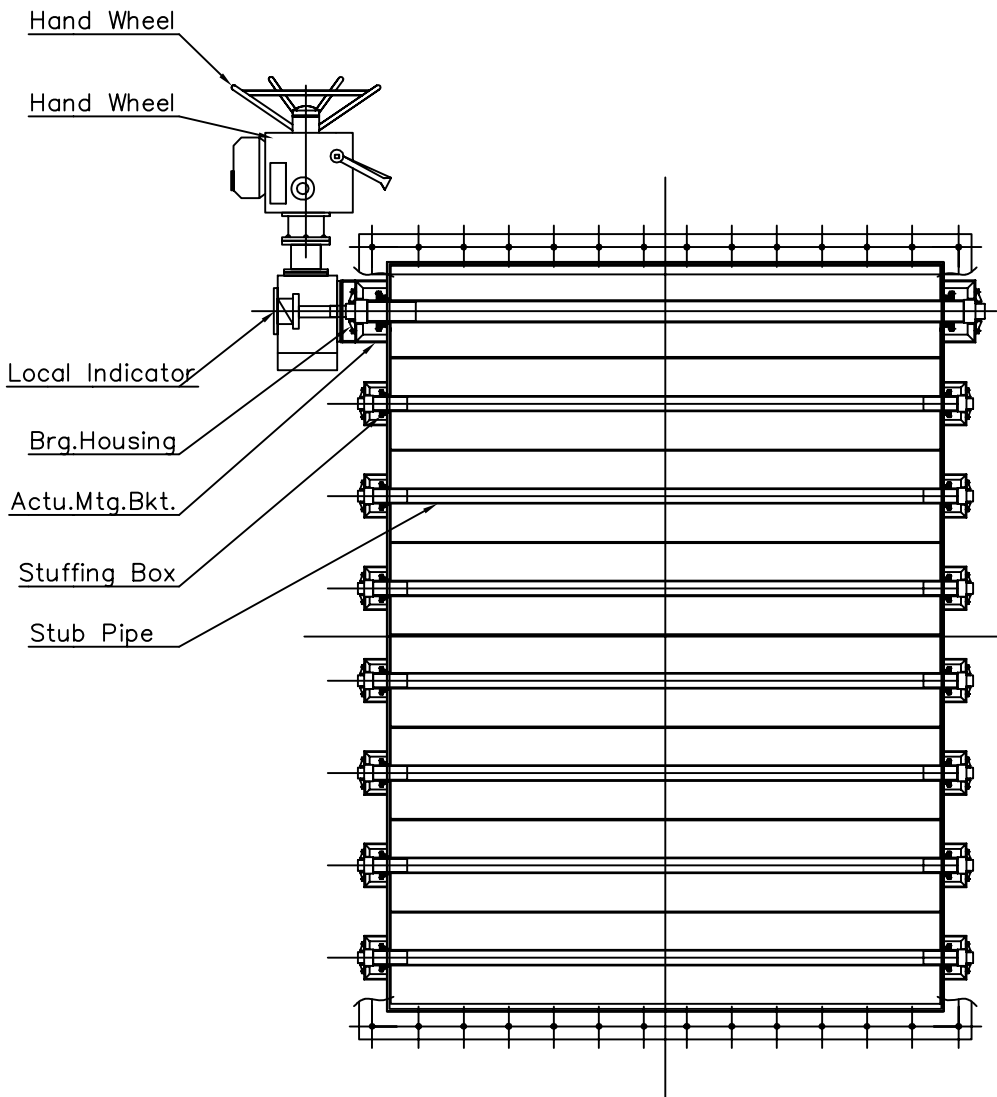

TITLE: G. A. FOR MULTI LOUVER DAMPER



marsh automation pvt. ltd.

98A/25A, Hadapsar Industrial Estate,
Pune - 411 013. (INDIA)

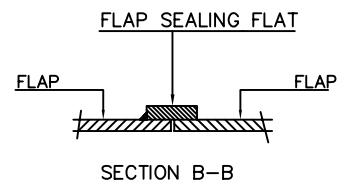
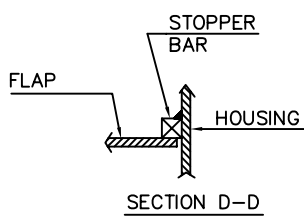
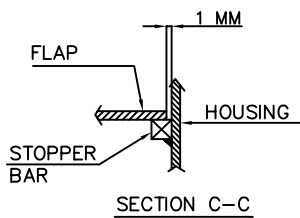
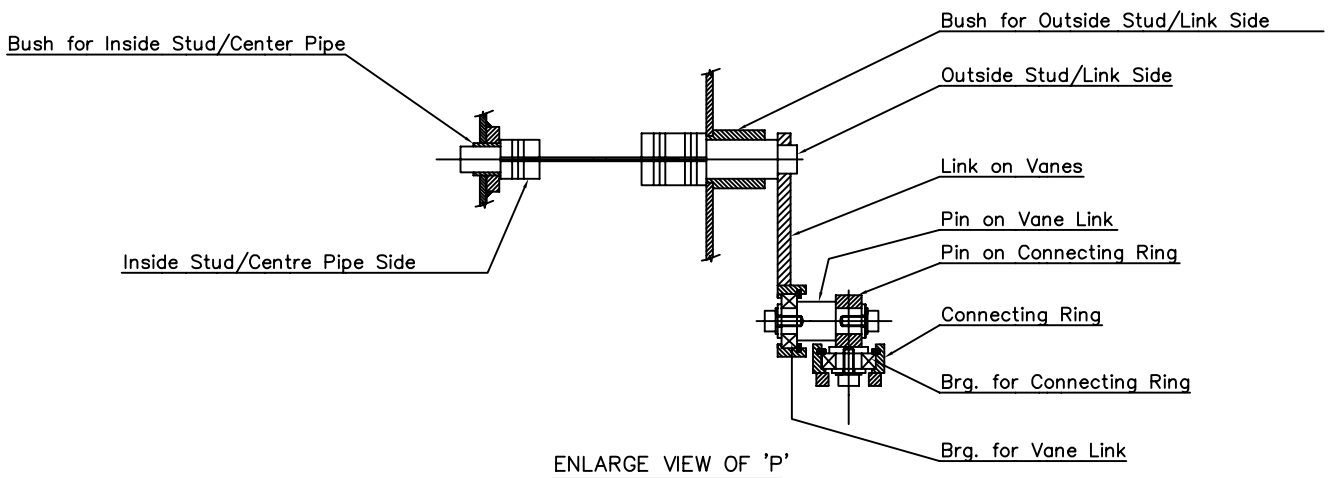
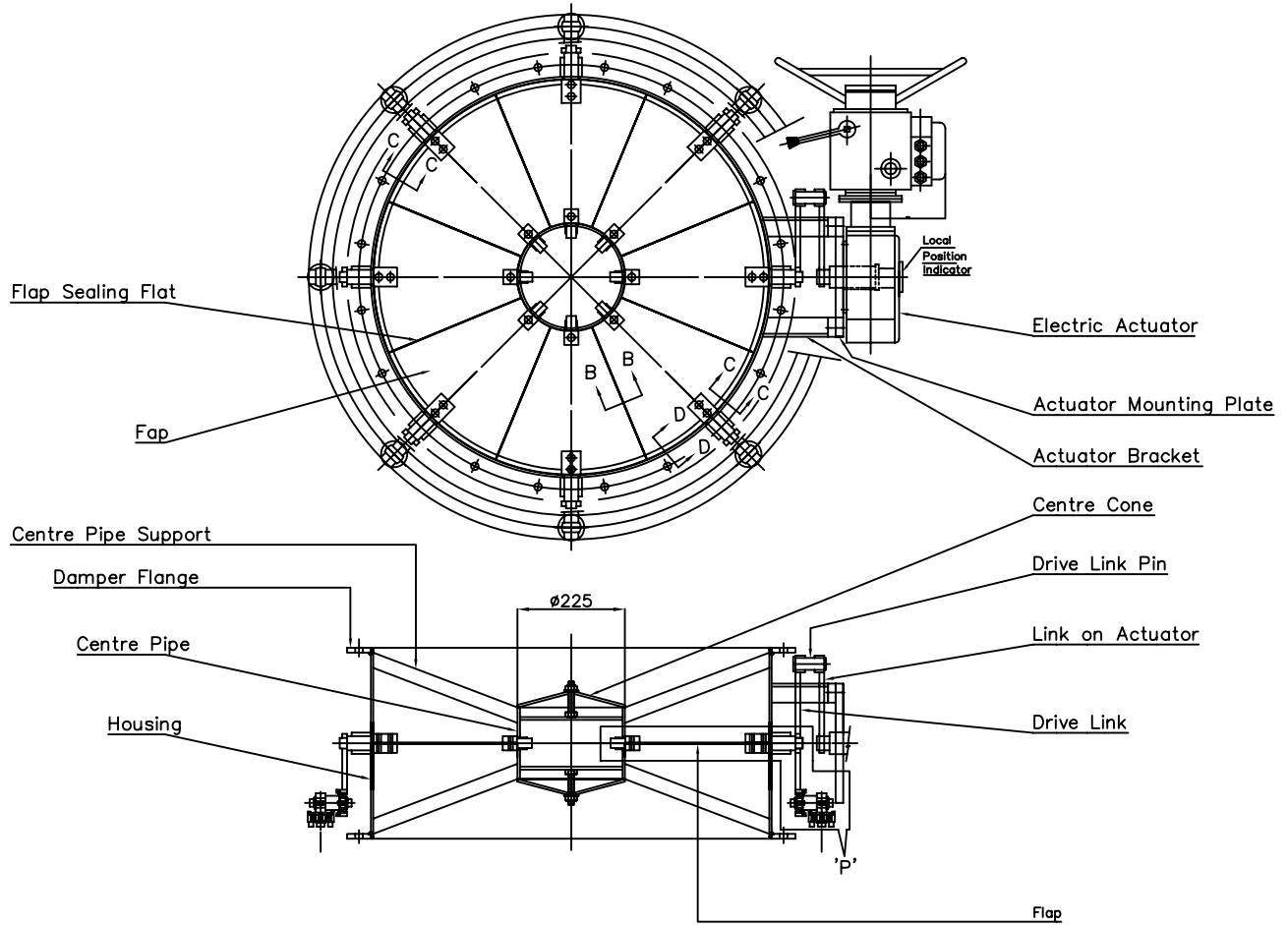

TITLE: G. A. FOR VERIABLE INLET VANES



marsh automation pvt. ltd.

98A/25A, Hadapsar Industrial Estate,
Pune - 411 013. (INDIA)